

INSTRUCTIONS FOR INSTALLATION OF TUBULAR LOCKSETS

IMPORTANT: "Backset" is the distance from the edge of the door to the center of the lock. It is either 2 3/8" (60mm), or 2 3/4" (70mm). Decide your preference.

BEFORE STARTING, READ ALL INSTRUCTIONS

1. ADJUSTABLE LATCH FOR 2-3/8" (60mm) AND 2-3/4" (70mm) BACKSET

1. The adjustable latch can fit a 2 3/8" (60mm) backset or 2 3/4" (70mm) backset.
2. 4 Way latch includes a drive in latch and a latch face. If you need to remove latch face, just rotate latch face clockwise or counterclockwise 20° then pull out latch face.
3. The latch is preset at the factory for a 2 3/4" (70mm) backset.
4. If a 2 3/8" (60mm) backset is required, adjust the latch as shown below.

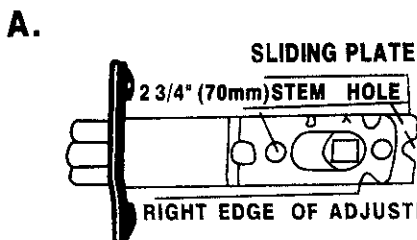

- Be sure the 2 3/4" (70mm) stem hole is properly aligned.
- Your latch is now set for a 2 3/4" (70mm) backset.



- Push spindle cam all the way to left edge of adjusting hole.



- This latch is for 2 3/8" (60mm) backset

2. MARK DOOR

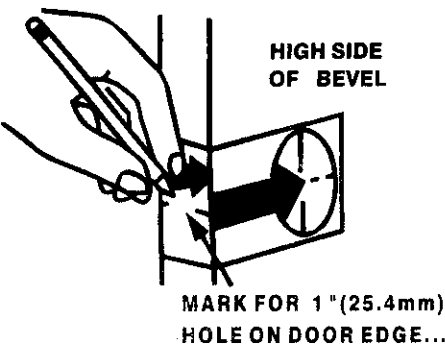

Start approximately 36" (914mm) from floor. Fold and apply template to high edge of door bevel and mark center of door edge as indicated on template.



Mark center hole on door face through guide on template for 2 3/8" (60mm) or 2 3/4" (70mm). **Note:** Backset on door face must be same as backset of lock.

3. DRILL HOLES

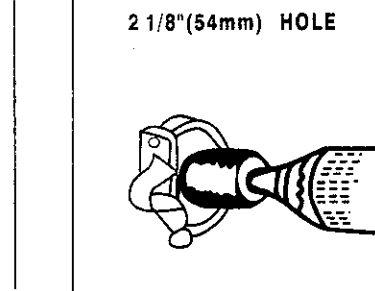

Drill 2 1/8" (54mm) hole through door face as marked for lockset. It is recommended that holes be drilled from both sides to prevent splitting.

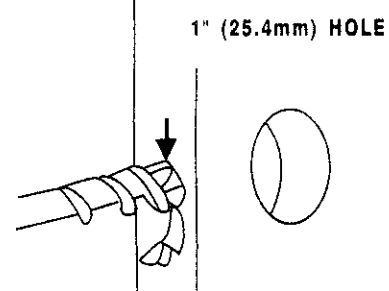

Drill 1" (25.4mm) hole in center of door edge for latch.

4. INSTALL LATCH

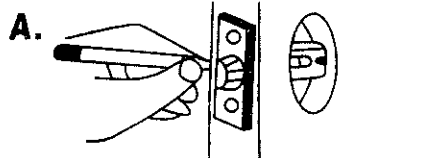

Insert latch in hole, keeping it parallel to face of door. Mark outline and remove latch.

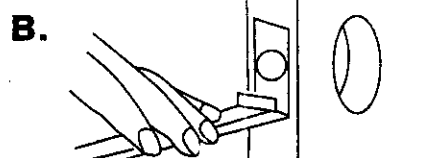

Chisel 1/8" (3mm) deep or until latch face is flush with door edge.

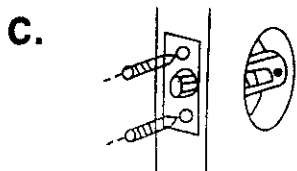

Insert latch and tighten screws.

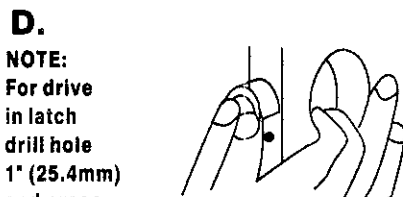

NOTE: For drive in latch drill hole 1" (25.4mm) and press latch until it is flush with door edge.

5. INSTALL STRIKE

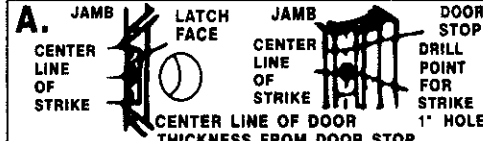

Close door until latch bolt touches jamb to locate strike in jamb and center line of strike. Open door and extend line from mark to door stop. Measure one half of door thickness from door stop and vertically mark and drill point center for strike.



Drill 1" (25.4mm) hole 1/2" (13mm) deep in door jamb on drill point for strike. **CAUTION:** To assure proper lockset function, hole in jamb must be drilled a full 1/2" (13mm) deep.

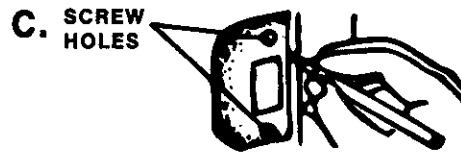

Match screw holes on strike with center line on jamb. Outline outside edge of strike. Chisel 1/16" (1.6mm) deep for strike.



Adjustable tang on strike permits bending in or out to eliminate too loose a fit between door and door stop. Install strike and tighten screws.

6. INSTALL EXTERIOR KNOB

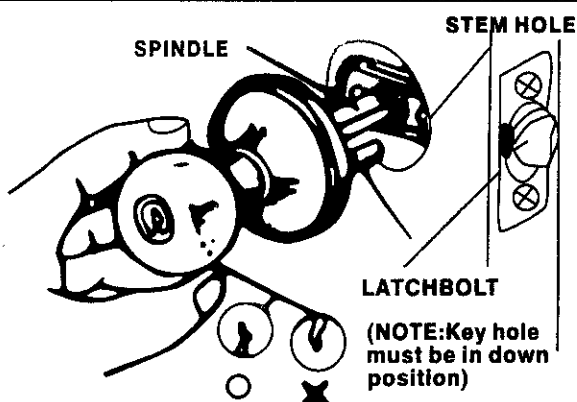

Insert knob of lever with spindle into latch, making certain that stems are positioned correctly through stem holes. Press flush against door.

7. INSTALL INTERIOR KNOB OR LEVER

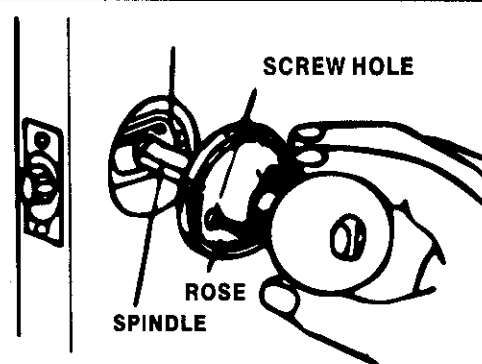

Install interior knob and rose by placing spindle through rose hole and aligning screw holes with stems. Push flush against door. Insert screws and tighten until lockset is firm.

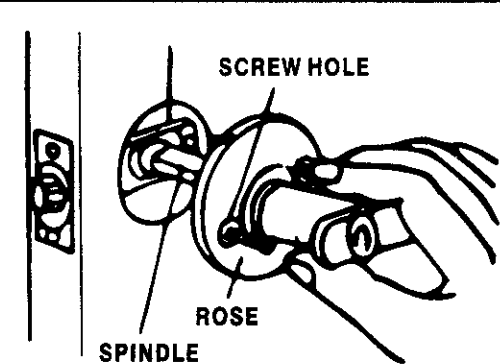

Install interior lever and rose by placing spindle through rose hole and aligning screw holes with stems. Push flush against door. Insert screws and tighten until lockset is firm.

INSTRUCTIONS POUR L'INSTALLATION DE SERRURES TUBULAIRES

IMPORTANT: "Ecartement" signifie la distance du bord de la porte au centre de la serrure.
Il est de 2 3/8 po (60mm), 2 3/4 po (70mm). Choisissez celui qui vous convient le mieux.

AVANT DE COMMENCER, LISEZ TOUTES LES DIRECTIVES

1. VERROU AJUSTABLE POUR UNE DISTANCE D'ENTREE DE 2 3/8" OU 2-3/4" (60mm at 70mm)

1. Ce verrou réglable peut être ajusté pour une distance d'entrée de 2 3/8" po (60mm) ou de 2 3/4" po (70mm)
2. Ce verrou comprend un verrou à enfoncer ainsi qu'une têtère. Pour retirer la têtère vous n'avez qu'à la faire pivoter de 20 degrés soit dans le sens des aiguilles d'une montre ou dans le sens inverse puis retirer la têtère
3. Le est pré-réglé en usine pour une distance de 2 3/4" po (70mm)
4. Pour une distance de 2 3/8" po (60mm), réglez le verrou tel que décrit ci-dessous.

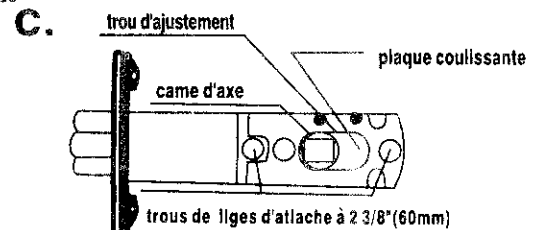
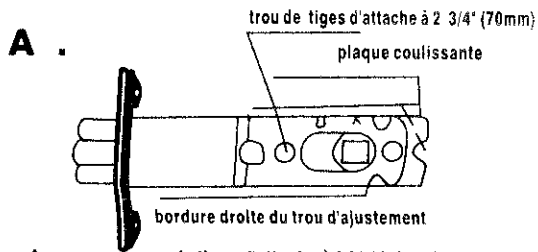
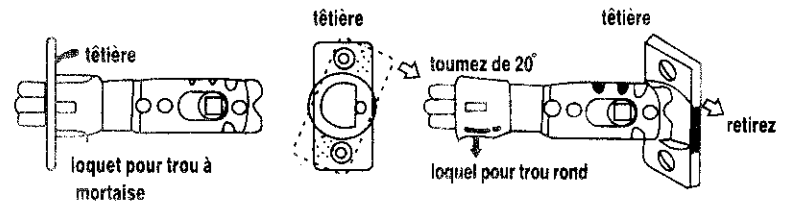

- Assurez-vous que la tiges d'attache à 2 3/4" (70mm) est bien alignée.
- Votre verrou est maintenant ajusté pour une distance de 2 3/4" (70mm).

Pousser le came d'axe complètement jusqu'à la bordure gauche du trou d'ajustement.

* Ce verrou est ajusté pour une distance entrée de 2 3/8" (60mm) sur la photo c

2. POSITIONNEMENT DES TROUS SUR LA PORTE



Commencez à environ 36" (914 mm) du sol, pliez et appliquez le gabarit en ligne avec le bord du champ de la porte et marquez le centre du champ tel qu'indiqué sur le gabarit.

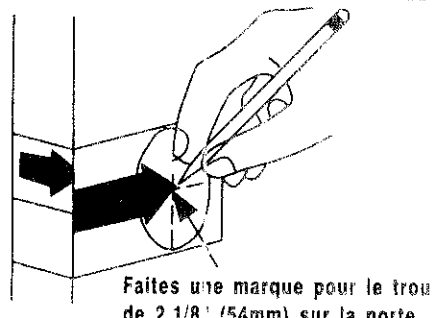

Marquez le centre du trou sur la porte à l'aide du repère sur le gabarit pour une distance d'entrée de 2 3/8" (60mm) ou 2 3/4" (70mm). NOTE: La distance d'entrée sur la porte doit correspondre à celle du verrou.

3. PERCAGE DES TROUS

trou de 2 1/8" (54mm)

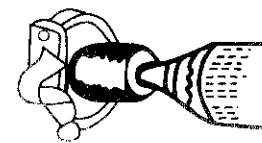

Percez un trou de 2 1/8" (54mm) (selon la serrure) de bord en bord de la porte. Il est recommandé de percer à partir des deux côtés pour prévenir le fendillement

trou de 1" (25.4mm)

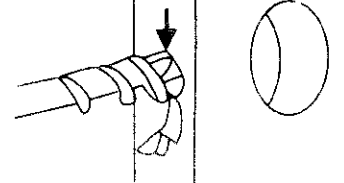

Percez un trou de 1" (25.4mm) dans le centre du champ de la porte pour le verrou.

4. INSTALLATION DU VERROU

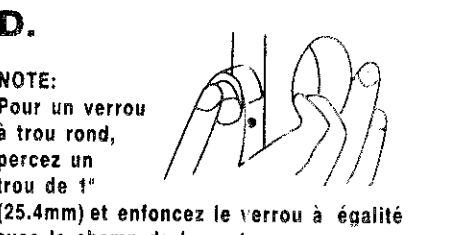
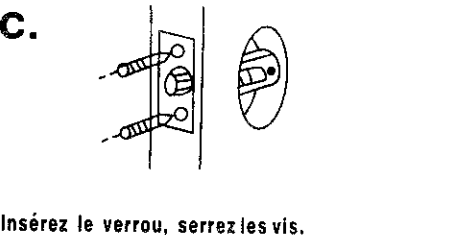
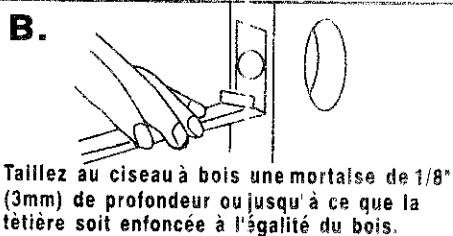
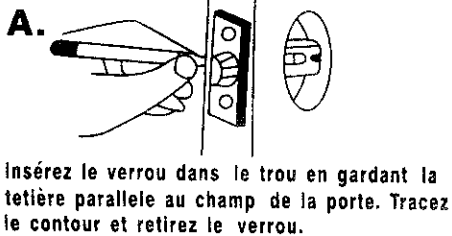

5. INSTALLATION DE LA GACHE



Fermez la porte jusqu'à ce que le pêne touche le jambage pour situer la gâche et sa ligne centrale sur le jambage. Ouvrez la porte et prolongez la ligne jusqu'au butoir. Mesurez la moitié de l'épaisseur de la porte à partir du butoir et faites une marque verticale pour indiquer l'endroit à percer pour la gâche.

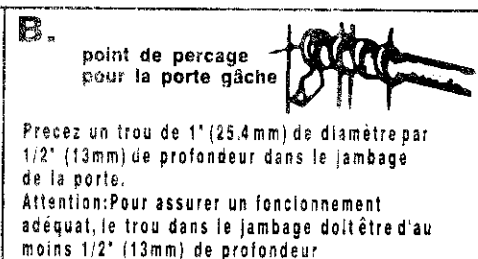

Perce un trou de 1" (25.4mm) de diamètre par 1/2" (13mm) de profondeur dans le jambage de la porte. Attention: Pour assurer un fonctionnement adéquat, le trou dans le jambage doit être d'au moins 1/2" (13mm) de profondeur

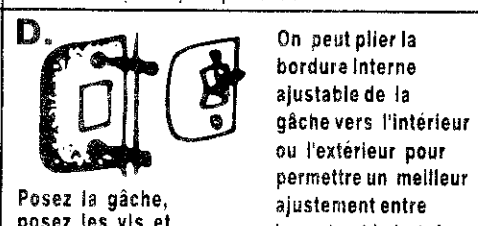

6. INSTALLATION DU BOUTON EXTERIEUR

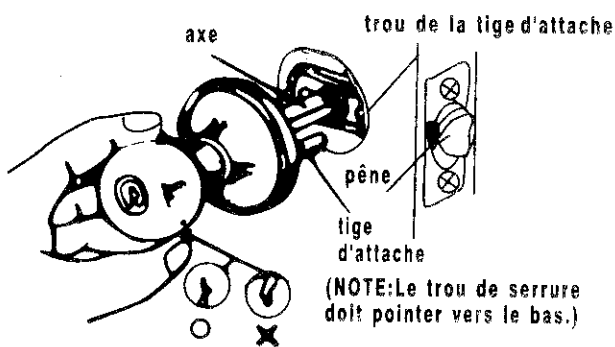

Insérez le bouton ou le bec-de-cane avec l'axe dans le verrou, en vous assurant que les tiges d'attaches sont bien placées dans leurs trous. Pressez contre la porte.

7. INSTALLATION DU BOUTON INTERIEUR OU DU BEC-DE-CANE

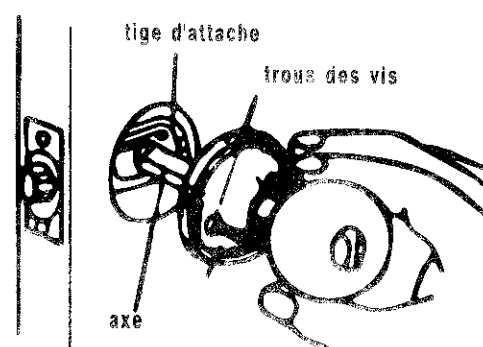

Installez le bouton intérieur et la rosette en plaçant l'axe dans le trou de la came et en alignant les tiges d'attache vis-à-vis leurs trous. Pressez contre la porte insérez les vis et serrez fermement.

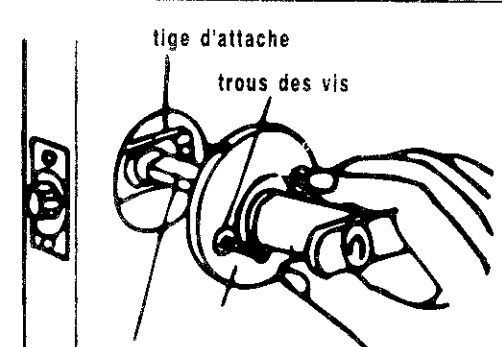

Installez le bec-de-cane intérieur et la rosette en plaçant l'axe dans le trou de la came et en alignant les tiges d'attache vis-à-vis leurs trous. Pressez contre la porte. Insérez les vis et serrez fermement.