

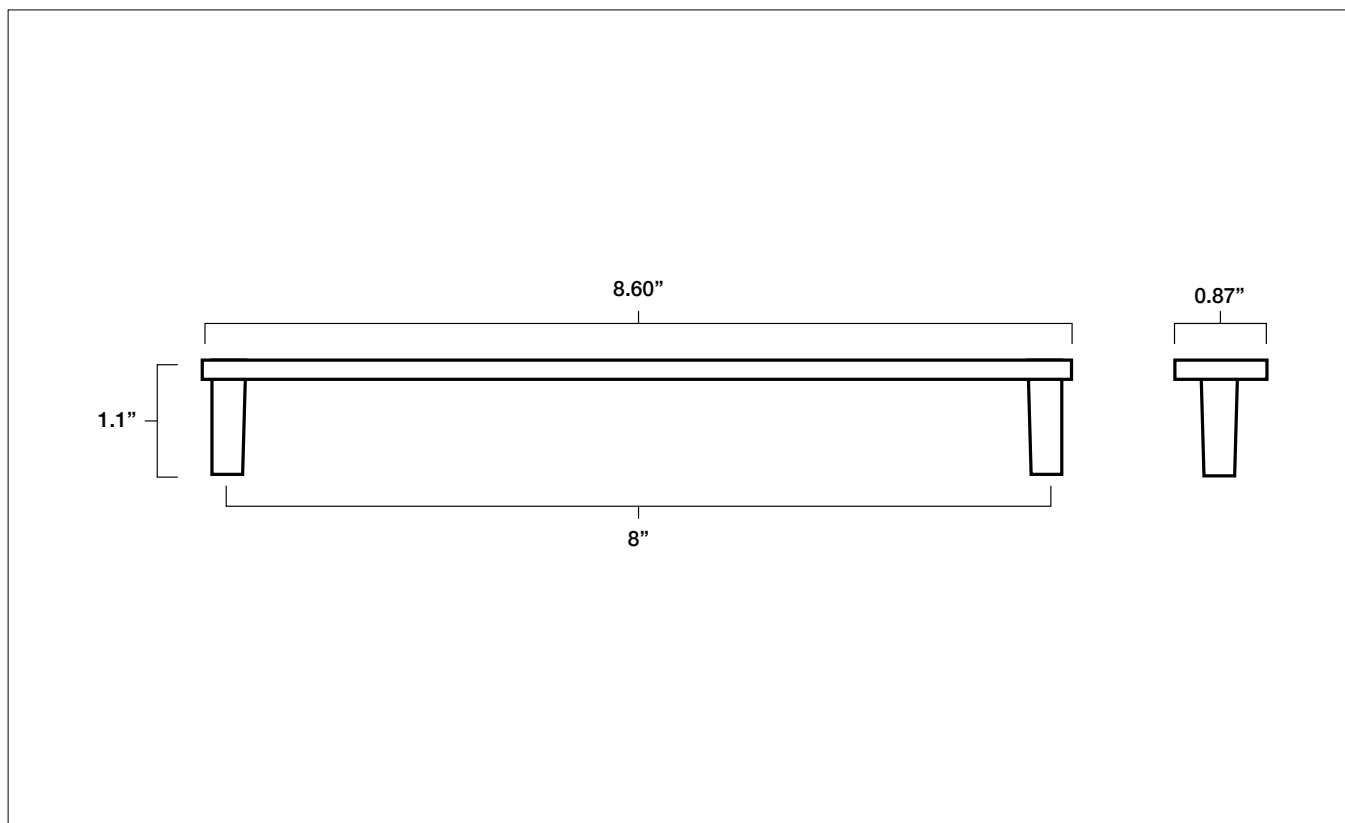

HORIZON 8" CABINET PULL

Tech Spec



FINISH	SKU	ALSO INCLUDED
Matte Black Polished Nickel Satin Brass Satin Nickel	H559-MB H559-PN H559-SB H559-SN	(2) 8-32, 1" Phillips head screws (2) 8-32, 1.75" Phillips head breakable screws

CARE INSTRUCTIONS:

Gentle is key. Clean your hardware with a soft, damp cloth, and wipe completely dry. Do not leave any water or soap residue on your product. Never use any chemicals or harsh over-the-counter cleaners, as these will strip the finish and void your warranty.